

YAMAHA PC-8

Natural Sound Component System

Chaîne de la Série "Naturel Sonore"

Bauteinsystem mit natürlichem Klang

Natural Sound Komponentensystem

Sistema de componentes de sonido natural



OWNER'S MANUAL

MODE D'EMPLOI

BEDIENUNGSANLEITUNG

BRUKSANVISNING

MANUAL DEL PROPIETARIO

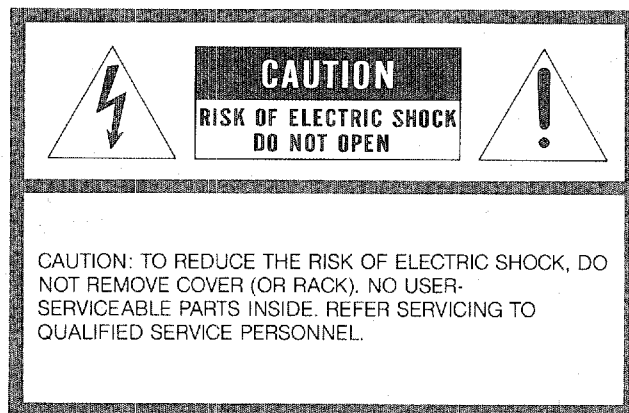

• Explanation of Graphical Symbols



The lightning flash with arrowhead symbol, within an equilateral triangle, is intended to alert you to the presence of uninsulated "dangerous voltage" within the product's enclosure that may be of sufficient magnitude to constitute a risk of electric shock to persons.

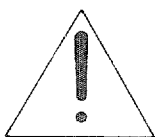

The exclamation point within an equilateral triangle is intended to alert you to the presence of important operating and maintenance (servicing) instructions in the literature accompanying the appliance.

Note:

When Power is supplied from a car battery, make sure the center pin is connected to the "+" positive terminal. Connecting the center pin to the "-" terminal will seriously damage the unit.

Radio Shack's "High Power DC Auto Adaptor" (Cat. No. 270-1562) is recommended for use as the car adaptor cord.

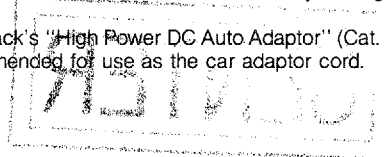

Die Deutsche Bundespost informiert

Sehr geehrter Rundfunkteilnehmer!

Dieses Gerät ist von der Deutschen Bundespost als Ton- bzw. Fernseh-Rundfunkempfänger zugelassen. Es entspricht den zur Zeit geltenden Technischen Vorschriften der Deutschen Bundespost und ist zum Nachweis dafür mit der FTZ-Prüfnummer gekennzeichnet. Bitte überzeugen Sie sich selbst.

Dieses Gerät darf im Rahmen der umseitig abgedruckten "Allgemeinen Genehmigung für Ton- und Fernseh-Rundfunkempfänger" in der Bundesrepublik Deutschland betrieben werden. Beachten Sie aber bitte, daß aufgrund dieser Allgemeinen Genehmigung nur Sendungen des Rundfunks empfangen werden dürfen.*) Wer unbefugt andere Sendungen (z.B. des Polizeifunks, des Seefunks, der öffentlichen beweglichen Landfunkdienste) empfängt, verstößt gegen die Genehmigungsaufgaben und macht sich daher nach § 15 Absatz 2 a des Gesetzes über Fernmeldeanlagen strafbar.

Die Kennzeichnung mit der FTZ-Prüfnummer bietet Ihnen die Gewähr, daß dieses Gerät keine anderen Fernmeldeanlagen einschließlich Funkanlagen stört. Die Zusatzbuchstaben S oder SK bei der FTZ-Prüfnummer besagen außerdem, daß das Gerät gegen störende Beeinflussungen durch andere Funkanlagen (z.B. des Amateurfunks, des CB-Funks) weitgehend unempfindlich ist. Sollten ausnahmsweise trotzdem Störungen auftreten, so wenden Sie sich bitte an die örtlich zuständige Funkstörungsmeßstelle.

*) Zum Empfang anderer Sendungen darf dieses Gerät nur mit Genehmigung der Deutschen Bundespost benutzt werden. Allgemein genehmigt ist zur Zeit der Empfang der Aussendungen von Amateurfunkstellen und der Normalfrequenz- und Zeitzeichensendungen.

Allgemeine Genehmigung für Ton- und Fernseh-Rundfunkempfänger

Die Allgemeine Ton- und Fernseh-Rundfunkgenehmigung vom 11. Dezember 1970 (veröffentlicht im Bundesanzeiger Nr. 234 vom 16. Dezember 1970) wird unter Bezug auf Abschnitt III der Genehmigung durch folgende Fassung der Allgemeinen Genehmigung für Ton- und Fernseh-Rundfunkempfänger gemäß den §§ 1 und 2 des Gesetzes über Fernmeldeanlagen ersetzt.

Genehmigung für Ton- und Fernseh-Rundfunkempfänger

I.

1. Die Errichtung und der Betrieb von Ton- und Fernseh-Rundfunkempfängern werden nach §§ 1 und 2 des Gesetzes über Fernmeldeanlagen in der Fassung der Bekanntmachung vom 17. 3. 77 (BGBl. I S. 459) allgemein genehmigt.
2. Ton- und Fernseh-Rundfunkempfänger im Sinne dieser Genehmigung sind Funkanlagen gemäß § 1 Abs. 1 des Gesetzes über Fernmeldeanlagen, die ausschließlich die für Rundfunkempfänger zugelassenen Frequenzabstimmbereiche*) aufweisen und zum Aufnehmen und gleichzeitigen Hör- oder Sichtbarmachen von Ton- oder Fernseh-Rundfunksendungen bestimmt sind. Zum Empfänger gehören auch eingebaute oder mit ihm fest verbundene Antennen sowie bei Unterteilung in mehrere Geräte die funktionsmäßig zugehörenden Geräte.

Außer für den Empfänger von Rundfunksendungen dürfen Ton- und Fernseh-Rundfunkempfänger nur mit besonderer Genehmigung der Deutschen Bundespost für andere Fernmeldezwecke zusätzlich benutzt werden.

In den Empfänger eingebaute oder sonst mit ihm verbundene Zusatzgeräte (z.B. Ultraschallfermeldeanlagen, Infrarotfermeldeanlagen) werden von dieser Genehmigung nicht erfaßt (ausgenommen die Einrichtungen zum Empfang des Verkehrsroundfunks). Desgleichen sind andere technische Empfängereigenschaften, die über den eigentlichen Zweck eines Rundfunkempfängers hinausgehen (z.B. zum Empfang anderer Funkdienste, für die Wiedergabe im Rahmen von Textübertragungsverfahren), hierdurch nicht genehmigt. Hierfür gelten besondere Regelungen.

II.

Diese Genehmigung wird unter nachstehenden Auflagen erteilt:

1. Ton- und Fernseh-Rundfunkempfänger müssen den jeweils geltenden Technischen Vorschriften für Ton- und Fernseh-Rundfunkempfänger entsprechen. Eingebaute Zusatzgeräte müssen den für sie geltenden Bestimmungen und technischen Vorschriften genügen.

Änderungen der Technischen Vorschriften, die im Amtsblatt des Bundesministers für das Post- und Fernmeldewesen veröffentlicht werden, muß bei schon errichteten und in Betrieb genommenen Ton- und Fernseh-Rundfunkempfängern nachgekommen werden, wenn durch den Betrieb dieser Rundfunkempfänger andere elektrische Anlagen gestört werden.

Serienmäßig hergestellte Ton- und Fernseh-Rundfunkempfänger müssen zum Nachweis dafür, daß sie den technischen Vorschriften entsprechen, mit einer FTZ-Prüfnummer gekennzeichnet sein.***) Die FTZ-Prüfnummer sagt über die elektrische und mechanische Sicherheit und die Einhaltung der Strahlenschutzbestimmungen nichts aus.

2. Ton- und Fernseh-Rundfunkempfänger dürfen an ortsfesten oder nichtortsfesten Rundfunk-Empfangsantennenanlagen, -Verteilanlagen oder Kabelfernsehantennen betrieben und im Rahmen der Bestimmungen über private Drahtfermeldeanlagen mit Drahtfermeldeanlagen verbunden werden.

Auf demselben Grundstück oder innerhalb eines Fahrzeuges dürfen Ton- und Fernseh-Rundfunkempfänger mit anderen Geräten oder sonstigen Gegenständen (z.B. Plattenspieler, Magnetaufzeichnungs- und -Wiedergabegeräten, Antennen) verbunden werden, sofern diese Geräte von der Deutschen Bundespost genehmigt sind oder keiner Genehmigung bedürfen.

Die räumliche Kombination von Funkanlagen mit Ton- oder Fernseh-Rundfunkempfängern ist nur dann zulässig, wenn die betreffenden Funkanlagen je für sich genehmigt sind.

3. Mit Ton- oder Fernseh-Rundfunkempfängern dürfen aufgrund dieser Genehmigung nur Sendungen des Rundfunks empfangen werden, also übertragene Tonsignale (Musik, Sprache) und Fernsehsignale (nur Bildinformationen). Andere Sendungen (z. B. des Polizeifunks, der öffentlichen beweglichen Landfunkdienste, Datenübertragungen) dürfen nicht aufgenommen werden; werden sie jedoch unbeabsichtigt empfangen, so dürfen sie weder aufgezeichnet noch anderen mitgeteilt noch für irgendwelche Zwecke ausgewertet werden. Das Vorhandensein solcher Sendungen darf auch nicht anderen zur Kenntnis gebracht werden.

4. Durch Ton- oder Fernseh-Rundfunkempfänger darf der Betrieb anderer elektrischer Anlagen nicht gestört werden.

5. Änderungen der Ton- oder Fernseh-Rundfunkempfänger, die die zulässigen Frequenzabstimmbereiche der Empfänger erweitern, gehen über den Umfang dieser Genehmigung hinaus und bedürfen vor ihrer Ausführung einer besonderen Genehmigung der Deutschen Bundespost.

Wer aufgrund dieser Genehmigung einen Ton- oder Fernseh-Rundfunkempfänger betreibt, hat bei einer Änderung der kennzeichnenden Merkmale von Ton- oder Fernseh-Rundfunksendern (insbesondere bei Änderung des Sendeverfahrens oder bei Frequenzwechsel) die ggf. notwendig werdenden Änderungen an dem Rundfunkempfänger auf seine Kosten vornehmen zu lassen.

6. Die Deutsche Bundespost ist berechtigt, Rundfunkempfänger und mit ihnen verbundene Geräte darauf zu prüfen, ob die Auflagen der Genehmigung und die Technischen Vorschriften eingehalten werden.

Den Beauftragten der Deutschen Bundespost ist das Betreten der Grundstücke oder Räume, in denen sich Ton- oder Fernseh-Rundfunkempfänger befinden, zu den verkehrsüblichen Zeiten zu gestatten. Befinden sich die Rundfunkempfänger oder mit ihnen verbundene Geräte nicht im Verfügungsbereich desjenigen, der die Empfänger betreibt, so hat er den Beauftragten der Deutschen Bundespost Zutritt zu diesen Teilen zu ermöglichen.

III.

Bei Funkstörungen, die nicht durch Mängel der Rundfunkempfänger oder der mit ihnen verbundenen Geräte verursacht werden, können die Funkmeßdienste der Deutschen Bundespost zur Feststellung der Störung in Anspruch genommen werden.

1. Diese Genehmigung kann allgemein oder durch die örtlich zuständige Oberpostdirektion einem einzelnen Betreiber gegenüber für einen bestimmten Rundfunkempfänger widerrufen werden. Ein Widerruf ist insbesondere zulässig, wenn die unter Abschnitt II aufgeführten Auflagen nicht erfüllt werden.

Anstatt die Genehmigung zu widerrufen, kann die Deutsche Bundespost anordnen, daß bei einem Verstoß gegen eine Auflage ein Ton- oder Fernseh-Rundfunkempfänger außer Betrieb zu setzen ist und erst bei Einhaltung der Auflagen wieder betrieben werden darf.

Die Auflagen dieser Genehmigung können jederzeit ergänzt oder geändert werden.

2. Diese Genehmigung ersetzt die Allgemeine Ton- und Fernseh-Rundfunkgenehmigung vom 11. Dezember 1970, sie gilt ab 1. Juli 1979.

Bonn, den 14. 5. 1979

Der Bundesminister für
das Post- und Fernmeldewesen
Im Auftrag
Haist

*) Siehe Technische Vorschriften für Ton- und Fernseh-Rundfunkempfänger, veröffentlicht im Amtsblatt des Bundesministers für das Post- und Fernmeldewesen.

**) Für ausnahmsweise noch nicht gekennzeichnete, vor dem 1. Juli 1979 errichtete und in Betrieb genommene Ton-Rundfunkempfänger wird die Kennzeichnung nicht verlangt.

CAUTION (PREPARED IN ACCORDANCE WITH UL STANDARD 1270)

1. Read Instructions — All the safety and operating instructions should be read before the appliance is operated.

2. Retain Instructions — The safety and operating instructions should be retained for future reference.

3. Head Warnings — All warnings on the appliance and in the operating instructions should be adhered to.

4. Follow Instructions — All operating and other instructions should be followed.

5. Water and Moisture — The appliance should not be used near water — for example, near a bathtub, washbowl, kitchen sink, laundry tub, in a wet basement, or near swimming pool, etc.

6. Carts and Stands — The appliance should be used only with a cart or stand that is recommended by the manufacturer.

7. Wall or Ceiling Mounting — The appliance should be mounted to a wall or ceiling only as recommended by the manufacturer.

8. Ventilation — The appliance should be situated so that its location or position does not interfere with its proper ventilation. For example, the appliance should not be situated on a bed, sofa, rug, or similar surface that may block the ventilation openings; or placed in a built-in installation, such as a bookcase or cabinet that may impede the flow of air through the ventilation openings.

9. Heat — The appliance should be situated away from heat sources such as radiators, stoves, or other appliances that produce heat.

10. Power Sources — The appliance should be connected to a power supply only of the type described in the operating instructions or as marked on the appliance.

11. Power-Cord Protection — Power-supply cords should be routed so that they are not likely to be walked on or pinched by items placed upon or against them, paying particular attention to cords at plugs, convenience receptacles, and the point where they exit from the appliance.

12. Cleaning — The appliance should be cleaned only as recommended by the manufacturer.

13. Nonuse Periods — The power cord of the appliance should be unplugged from the outlet when left unused for a long period of time.

14. Object and Liquid Entry — Care should be taken so that objects do not fall into and liquids not spilled into the inside of the appliance.

15. Damage Requiring Service — The appliance should be serviced by qualified service personnel when:

- A. The power-supply cord or the plug has been damaged; or
- B. Objects have fallen, or liquid has been spilled into the appliance; or
- C. The appliance has been exposed to rain; or
- D. The appliance does not appear to operate normally or exhibits a marked change in performance; or
- E. The appliance has been dropped, or the cabinet damaged.

16. Servicing — The user should not attempt to service the appliance beyond those means described in the operating instructions. All other servicing should be referred to qualified service personnel.

17. Power Lines — An outdoor antenna should be located away from power lines.

18. Outdoor antenna grounding — If an outside antenna is connected to the tuner, be sure the antenna system is grounded so as to provide some protection against voltage surges and built up static charges. Section 810 of the National Electrical Code, ANSI/NFPA No. 70 — 1981, provides information with respect to proper grounding of the mast and supporting structure, grounding of the lead-in wire to an antenna discharge unit, size of grounding conductors, location of antenna-discharge unit, connection to grounding electrodes, and requirements for the grounding electrode.

EXAMPLE OF ANTENNA GROUNDING AS PER NATIONAL ELECTRICAL CODE INSTRUCTIONS

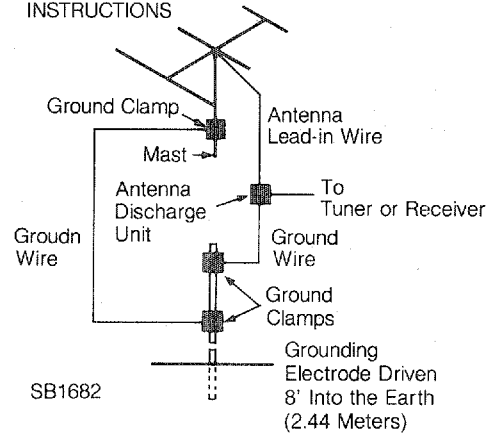

- a. Use No. 10 AWG (5.3 mm²) copper, No. 8 AWG (8.4 mm²) aluminium, No. 17 AWG (1.0 mm²) copper-clad steel or bronze wire, or larger, as ground wire.
- c. Secure antenna lead-in and ground wire to house with stand-off insulators spaced from 4 feet (1.22 meters) to 6 feet (1.83 meters) apart.
- c. Mount antenna discharge unit as closely as possible to where lead-in enters house.

PC-8

● Thank you for purchasing the YAMAHA PC-8 component system.

● YAMAHA vous remercie d'avoir choisi le PC-8.

● YAMAHA beglückwünscht Sie zu Ihrem neuen PC-8

CAUTION: READ THIS BEFORE OPERATING YOUR PC-8

1. The PC-8 is a sophisticated component system. To ensure proper operation for the best possible sound reproduction, please read this manual carefully.
2. Choose the installation location of your PC-8 carefully. Avoid placing it in direct sunlight or close to a source of heat. Also avoid locations subject to vibration and excessive dust, heat, cold or moisture.
3. Do not open the cabinet as this might result in damage to the set, or electrical shock. If a foreign object should get into the set, contact your dealer.
4. When removing the power plug from the wall outlet, always pull directly on the plug; never yank the cord.
5. To prevent lightning damage, pull out the power cord and remove the antenna cable in case of an electrical storm.
6. Do not use force when using the switches and knobs.
7. Always set the volume control to "0" while lowering the tonearm to play a record, then turn the volume up after the stylus is seated in the record groove.
8. Do not attempt to clean the PC-8 with chemical solvents as this might damage the finish. Use a clean, dry cloth.
9. Be sure to read the "troubleshooting" section for advice on common operating errors before concluding that your PC-8 is faulty.
10. Keep this manual in a safe place for future reference.

11. If your PC-8 has a voltage selector, check that it is set to your local voltage before you plug it in. If not properly set, unscrew the two switchguard retaining screws, and reset the switch to indicate your supply voltage.

IMPORTANT

Please record the serial number of your unit in the space below.

Model: PC-8

Serial No.:

The serial number is located on the rear of the cabinet. Retain this Owner's Manual in a safe place for future reference.

Special Instructions for British Model
THE WIRES IN THE MAINS LEAD ARE COLOURED IN ACCORDANCE WITH THE FOLLOWING CODE:

Blue: NEUTRAL
Brown: LIVE

As the colours of the wires in the mains lead of this apparatus may not correspond with the coloured markings identifying the terminals in your plug, proceed as follows. The wire which is coloured BLUE must be connected to the terminal which is marked with the letter N or coloured BLACK. The wire which is coloured BROWN must be connected to the terminal which is marked with the letter L or coloured RED.

WARNING

To prevent fire or electrical shock, do not expose this PC-8 to rain or moisture.

ATTENTION: A LIRE AVANT TOUTE MISE SOUS TENSION

1. Le PC-8 est un appareil de haute précision. Lisez soigneusement le présent mode d'emploi pour l'utiliser au mieux de ses nombreuses possibilités.
2. N'installez pas votre PC-8 n'importe où. Évitez: le plein soleil, a proximité de sources de chaleur, les vibrations, la poussière, le froid excessif et l'humidité.
3. N'ouvrez pas votre PC-8. Si un corps étranger tombe à l'intérieur, contactez votre Agent Yamaha.
4. En cas d'orage débranchez le cordon secteur et la descente d'antenne.
5. Pour débrancher le cordon secteur, tirez la prise en la saisissant par le corps et non par le fil.
6. En cas d'orage il est prudent de débrancher du secteur et de débrancher le câble de descente d'antenne.
7. Ne forcez pas les commandes. Manoeuvrez tous les poussoirs doucement.
8. Pour déplacer l'appareil, débranchez d'abord tous les cordons, y compris le cordon secteur.
9. Avant de laisser la cellule de lecture se poser sur le disque, baissez toujours le volume sonore ("0").
10. N'utilisez aucun produit chimique pour le nettoyage sous peine d'endommager la finition. Un simple essuyage à sec, à l'aide d'un linge propre suffit.
11. En cas d'incident, reportez d'abord à la liste des fausses manoeuvres avant de contacter votre Agent Yamaha.

12. Conservez ce mode d'emploi en lieu sûr. Vous pourrez en avoir besoin un jour.
13. Pour assurer un excellent fonctionnement de cet appareil, installez-le de niveau et n'en obtenez pas les ouies d'aération.

IMPORTANT

Veillez s'il vous plaît noter ci-dessous le numéro de série de votre appareil (Il figure sur le châssis, à l'arrière):

MODELE: PC-8
N° SERIE:

Conservez le présent Mode d'emploi soigneusement. Vous pourrez en avoir besoin un jour.

AVERTISSEMENT

Pour éviter tout risque d'accident électrique, n'exposez pas cet appareil à une humidité excessive.

WICHTIG: BITTE LESEN SIE INBETRIEBNAHME IHRES

1. PC-8 ist ein hochentwickeltes Bausteinsystem. Bitte lesen Sie sorgfältig diese Anweisungen, im eine sachgemäße Bedienung und bestmöglichen Klang zu gewährleisten.
2. Wählen Sie die Anschlußstelle Ihres PC-8 mit Sorgfalt. Vermeiden Sie das Aufstellen indirekter Sonneneinstrahlung oder nahe eines Hitzeausgangspunktes. Auch ein Platz, der Vibrationen ausgesetzt ist, als auch übermäßig Staub, Hitze, Kälte oder Feuchtigkeit sind zu vermeiden.
3. Das Gehäuse sollte nicht geöffnet werden, weil das eine Beschädigung des Gerätes oder elektrischen Schlag zur Folge haben könnte. Sollte ein Fremdkörper in das Gerätinnere gelangen, so verständigen Sie Ihren Händler.
4. Beim Herausnehmen des Stromsteckers sollte immer direkt am Stecker gezogen und nicht an der Schnur gerissen werden.
5. Ziehen Sie im Falle eines Gewitters den Stecker heraus und entfernen Sie das Antennenkabel, um Schaden durch Blitzeinschlag vorzubeugen.
6. Beim Gebrauch der Schalter keine übermäßige Kraft anwenden.
7. Vor dem Aufsetzen des Tonarmes auf eine Schallplatte immer den Lautstärkenregler auf "0" stellen, und wenn die Tonabnehmernadel in der Plattenrinne liegt, kann die Lautstärke wieder eingestellt werden.
8. Versuchen Sie nicht, das PC-8-Gerät mit einem chemischen Lösungsmittel zu reinigen, weil das den Lack beschädigen könnte. Verwenden Sie ein sauberes, trockenes Tuch.

DIESE ANWEISUNGEN VOR PC-8BAUSTEINSYSTEMS

9. Bevor Sie einen Defekt Ihres PC-8 annehmen, lesen Sie bitte den Abschnitt über Fehlerquellen zwecks Ratschlag für häufig auftretende Bedienungsfehler.

10. Bewahren Sie diese Anleitungen für späteren Bedarf an einem sicheren Platz auf.

11. Wenn Ihr PC-8 einen Spannungsumschalter besitzt, sehen Sie nach, ob er auf die örtliche Netzspannung eingestellt ist, bevor Sie das Gerät anschließen. Wenn es nicht richtig eingestellt ist, schrauben Sie die beiden Schaltschutzschrauben ab und stellen Sie den Schalter entsprechend Ihrer Netzspannung um.

WICHTIG

Bitte notieren Sie die Fabriknummer Ihres Gerätes hierauf folgend.

Modell: PC-8

Fabriknummer:

Die Fabriknummer steht hinten auf dem Gehäuse. Bewahren Sie die Besitzeranleitungen für späteren Bedarf an einem sicheren Platz auf.

VORSICHT

Um Feuer oder elektrischen Schlag zu vermeiden, sollte das PC-8-Gerät nicht dem Regen oder Feuchtigkeit ausgesetzt werden.

OBSERVERA! LÄS DETTA INNAN DU ANVÄNDER DIN PC-8

1. PC-8 är ett sofistikerat komponentsystem. För att garantera att det används rätt och att du får bästa möjliga ljudåtergivning, bör du läsa denna bruksanvisning noga.

2. Välj placering för PC-8 noggrant. Undvik att placera den i direkt solsken eller nära ett värmeelement. Undvik också platser som utsätts för skakningar eller mycket damm, hetta, kyla eller fukt.

3. Tag inte av höljiet eftersom det kan skada apparaten eller förorsaka elektriska stötar. Om ett frammande föremål hamnar inuti apparaten, bör du kontakta din handlare.

4. När du tar ut stickproppen ur vägguttaget, bör du ta direkt i själva kontakten. Drag aldrig i sladden!

5. För att förhindra skador av blixtnedslag bör du dra ut sladden och ta bort antennanslutningen vid åskväder.

6. Använd inte våld när du handhar omkopplare och kontroller.

7. Ställ alltid ljudstyrkelkontrollen i läge "0" då du sänker ned tonarmen för att spela en skiva, vrid sedan upp ljudstyrkelkontrollen efter att nålen har kommit ner i skivspåret.

8. Rengör inte PC-8 med kemiska lösningsmedel som kan skada ytan. Använd en torr ren trasa.

9. Läs alltid kapitlet "Felsökningsschema", som berättar om vanliga användarfel, innan du antar att PC-8 är felaktig.

10. Förvara denna bruksanvisning på ett säkert ställe för framtida användning.

OBSERVERA!

Stömställaren är sekundärt kopplad och skiljer ej från nätet. När apparaten ej används bör därför nätsladden ej vara ansluten till vägguttaget.

VARNING

För att förhindra brand eller en elektrisk stöt, utsätt inte apparaten för regn eller fukt.

VIKTIGT!

Anteckna serienumret på din apparat på platsen nedan.

Modellnamn: PC-8
Serienummer

ATENCIÓN: LEA LO SIGUIENTE ANTES DE USAR EL PC-8

1. El PC-8 es un sistema de componentes de gran complejidad. Lea este manual cuidadosamente para asegurarse un funcionamiento apropiado a fin de obtener la mejor reproducción posible de sonido.

2. Elija cuidadosamente la ubicación del PC-8. Evite exponerlo directamente a los rayos del sol o cerca de una fuente de calor. También evite lugares sometidos a vibraciones y polvo, calor, frío y humedad excesivos.

3. No abra el mueble porque se podrían producir daños al equipo o choques eléctricos. Consulte a su concesionario si algún objeto extraño se introduce en el equipo.

4. Siempre dre directamente del enchufe para sacarlo del tomacorriente de la pared y no del cordón mismo.

5. En caso de tormentas eléctricas, desconecte al cordón eléctrico y quite el cable de la antena.

6. No emplee una fuerza excesiva cuando opere los conmutadores y mandos.

7. Coloque siempre en "0" el control de volumen antes de bajar el brazo del tocadiscos entonces suba el volumen después que la aguja haya hecho contacto con el disco.

8. No intente limpiar el PC-8 con solventes químicos porque puede dañar el acabado. Use un paño limpio y seco.

9. Asegúrese de leer la sección "investigación de problemas" a fin de consultar sobre errores comunes de operación, antes de concluir que el R-50 está fallado.

10. Guarde este manual en un lugar seguro para futuras referencias.

11. Si su PC-8 tiene un selector de voltaje verifique si está en la posición del voltaje de su localidad antes de enchufarlo. Si así no fuera desatorndle los dos tornillos de la placa de seguridad y ubique el conmutador según el voltaje correspondiente (110 - 120 V ó 220 -240 V).

ADVERTENCIA

No exponga este aparato a la lluvia o humedad para evitar incendios o descargas eléctricas.

[IMPORTANTE]

Por favor tomar nota de número de serie de su unidad en espacio provisto a continuación.

Nombre del modelo: PC-8
Número de serie:

El número de serie está situado en la parte posterior del chasis.

Speaker System Installation

(1)

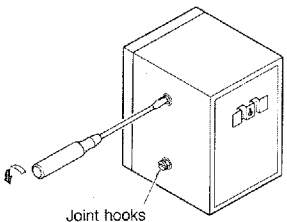

Left speaker

Joint hooks

Perform the same operation with the right speaker.

(2)

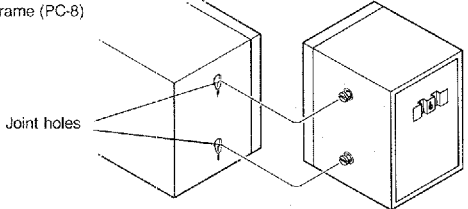

Main frame (PC-8)

Left speaker

Joint holes

Perform the same operation with the right speaker.

Hanging the Speakers on the Wall

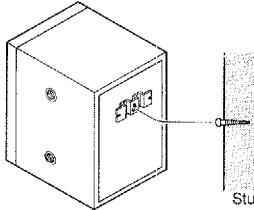

Screw inserted into wall (approx. 4 mm (1/8") in diameter and minimum length of 25 mm (1"))

Sturdy wall surface

Battery Installation

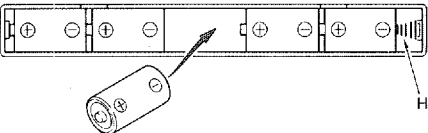

Holding spring

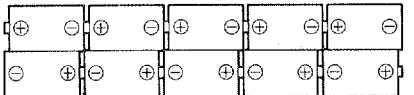

Make sure that the polarities of the batteries are inserted correctly, as shown in the diagram.

SPEAKER SYSTEM INSTALLATION

- (1) The upper and lower joint hooks are screwed onto the side of each speaker, left and right. Turn the joint counter-clockwise until it is pulled to its full length.
- (2) Connect each of the extended joint hooks of the speaker to the corresponding joint holes on each side of the main unit.

Note: Raising the handle to the erect position locks the speaker joint hooks in the holes of the main unit.

HANGING THE SPEAKERS ON THE WALL

On the back of the PC-8 speakers, a metal ring is attached to allow the speakers to be hung on a wall. The wall on which the speakers are hung should be of sturdy construction. Secure each screw (4 mm (1/8") in diameter and with a minimum 25 mm (1") length) in the wall with the head sufficiently projected from the wall, as shown, and hang the speaker on it.

BATTERY INSTALLATION

1. Open the battery compartment lid.
2. Install 10 size "D" (or R20) flashlight batteries into the battery compartment.
3. Close the battery compartment lid.

CONNECTION DIAGRAM

Do not push on the POWER switch until all the connections have been completed.

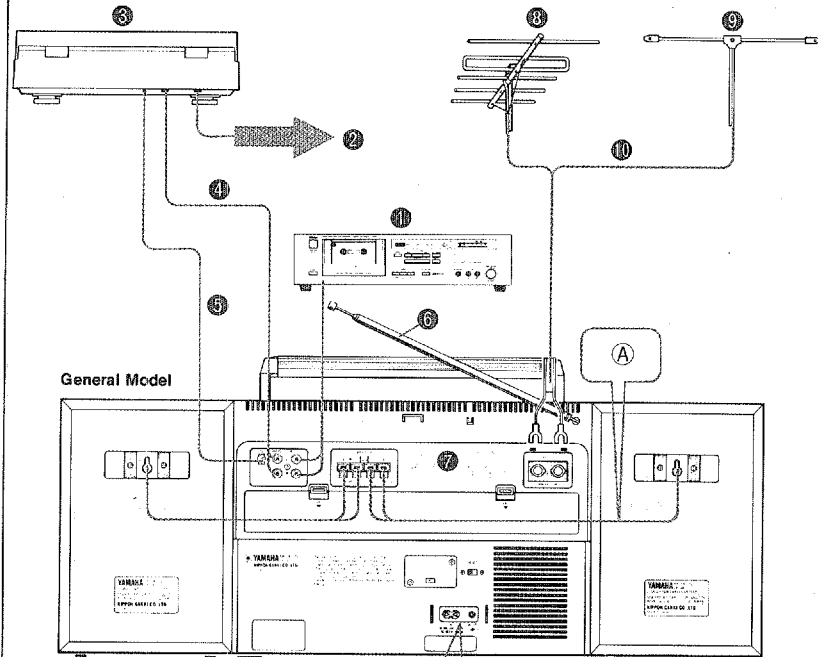

General Model

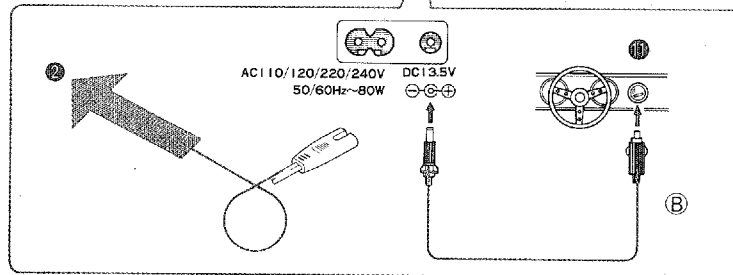

- ① Tape deck (external)
- ② AC outlet
- ③ Turntable
- ④ Output cord
- ⑤ GND
- ⑥ Telescopic antenna
- ⑦ Battery compartment lid
- ⑧ FM outdoor antenna
- ⑨ FM T-shaped indoor antenna
- ⑩ 300 ohm balanced feeder
- ⑪ Cigarette lighter socket
- A The wire marked with a red stripe is to be connected to the positive (+) terminal of the speaker.
- B Power may be supplied from the cigarette lighter socket of your car through an ordinary automobile battery adaptor.

U.S.A. and Canadian Models

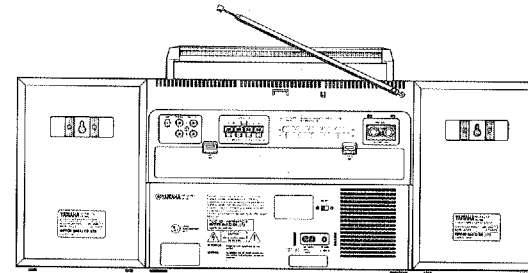

European Models

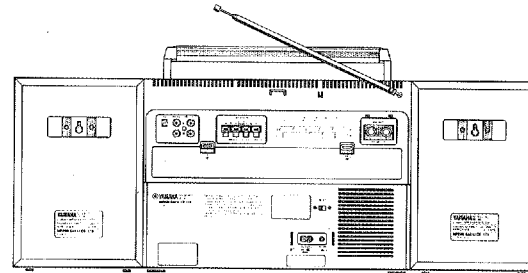

UK and Australian Models

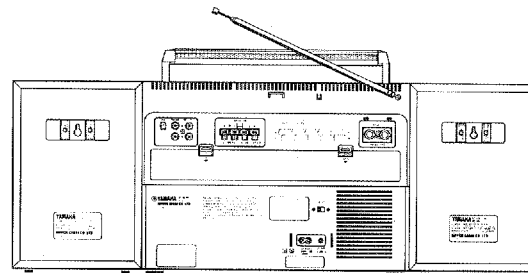

If your PC-8 has a voltage selector, check that it is set to your local voltage before you plug it in. If not properly set, reset the switch to indicate your supply voltage.

ANTENNA CONNECTION

FM Antenna

Turn on the POWER switch and tune in an FM station. Then, adjust the length, direction and angle of the telescopic antenna to obtain the best reception.

When the reception is unsatisfactory using the telescopic antenna, which could occur in areas far from the FM station, where nearby traffic causes excessive disturbances or where high-rise buildings interfere with the signal transmission, an FM indoor or outdoor antenna (300 ohms) available on the market may be connected to the "FM ANT" terminal instead of using the telescopic antenna. When using an external FM antenna, fold down the telescopic antenna.

Note: Please refer to the section on "Band Selector Switches According to Area".

Note: Do not carry your system around with the telescopic antenna extended as the antenna might be damaged if struck against something hard.

MW (AM) Antenna

The built-in ferrite bar antenna may be used to receive local MW (AM) stations. This antenna is a directional type, which means that broadcasts from distant stations may sometimes be improved by rotating the unit itself. When the ferrite bar antenna is used, the telescopic antenna should be folded down.

CONNECTIONS AND POWER SUPPLY

* Turntable installation

Note the colors, white (L) and red (R), of the record player output jacks, and connect the white jack to the PHONO L (left) terminal and the red jack to the PHONO R (right) terminal on the back panel.

* Connection to the recording auxiliary jacks

When another tape deck is used in addition to the one housed in the main unit, tape-to-tape dubbing, mixed playback of tape sources, etc. is possible. For this purpose, connect the left and right LINE IN jacks of the tape deck to the left and right auxiliary jacks on the back panel.

* Speaker system connection

In accordance with the connection diagram, connect the right speaker cord to the right SPEAKER terminals (left and right), and connect the left speaker cord to the left SPEAKER terminals (left and right), making sure the polarities are correctly connected. If the polarities of the speaker cords are reversed, no stereo sound is obtained.

Connect the speaker cords to the SPEAKER terminals as follows: While pressing down on the terminal tab just below the terminal, insert one end of the cord into the SPEAKER terminal hole, and then release the tab. This locks the end of the cord in the terminal hole.

POWER SUPPLY AC OUTLET

* Connect the attached power cord to the AC input jack on the back of the unit.

Even though the power cord is connected to an AC wall outlet, no power is supplied to the unit itself unless the power is turned on.

CHECKING THE DC POWER SOURCE (BUILT-IN BATTERIES OR CAR BATTERY)

1. Depress the POWER switch.
2. Note that the indicator above the POWER switch will light up. If the indicator starts to flicker, the batteries are getting weak.

If the unit is operated with a weak DC source:

* Recording and playback is impossible although radio broadcasts may be heard.

In addition, the YMS (Yamaha Music Search) system may fail to work properly.

When this condition arises, replace all batteries or operate the unit on AC power.

Note on Receiving Bands and Antennas

U.S.A. and Canadian models: The telescopic antenna provides reception for the FM band, and the built-in ferrite bar antenna provides reception for the MW (AM) bands.

Europe and U.K. models: The telescopic antenna provides reception for the FM and SW bands, and the built-in ferrite bar antenna provides reception for the MW and LW bands.

Other Area Models: The telescopic antenna provides reception for the FM and SW₂ bands and the built-in ferrite bar antenna provides reception for the MW and SW₁ bands.



Band Selector Switches According to Area

U.S.A. and Canada	FM 87.6 — 108.0MHz	MW (AM) 525 — 1605kHz		
Europe and U.K.	FM 87.6 — 108.0MHz	MW 525 — 1605kHz	LW 153 — 280kHz	SW 5.8 16.0MHz
Other Area	FM 87.6 — 108.0MHz	MW 525 — 1605kHz	SW ₁ 3.0 — 8.0MHz	SW ₂ 8.0 — 22.0MHz

BROADCAST RECEPTION

Broadcast Reception

* Follow the steps below in the correct sequence.

1. Turn ON the POWER switch.
2. Press the TUNER button of the INPUT selector buttons.
3. Press the desired Band selector button.
4. Leave the FM MUTING switch in the ON () position for normal FM tuning.
5. While observing the Dial indicator, turn the TUNING dial control to tune in the desired station.
6. Adjust the VOLUME controls to the desired volume level.
 - 1) If the received signal is a stereo broadcast, the FM STEREO indicator automatically lights up to indicate FM stereo reception. The indicator does not light up if the received signal is a monaural one.
 - 2) The SIGNAL indicator lights up automatically when a station is tuned in.
 - 3) The EQUALIZER switch may be turned ON () for desired frequency compensation.
 - 4) Slide the MIXING BALANCE control fully to the left.

• MUTING switch

The FM MUTING switch works only during FM reception or recording of an FM program. The switch has no effect on the playback or recording results on other sources than FM program sources.

• Telescopic Antenna

During FM reception, extend this telescopic antenna and adjust its length, direction and angle for the best reception results. When an external antenna is used, the telescopic antenna should be kept in its folded down position. The built-in ferrite bar antenna is

sufficient for reception of local MW (AM) broadcasts. Also keep the telescopic antenna folded down in this case as it does not work on the MW (AM)* bands.

The ferrite bar antenna is somewhat directional. Thus, reception may sometimes be improved by adjusting the location and position of the PC-8.
* Please refer to the section on "Band Selector Switches According to Area"

TAPE PLAYBACK

* Follow the steps below in the correct sequence.

1. Make sure that the TIMER switch is set to the OFF position.
 2. Turn ON the POWER switch.
 3. Press the TAPE button of the INPUT selector buttons.
 4. Load the cassette tape to be played back.
 5. Turn the DOLBY NR switch to the ON or OFF position depending on whether or not the tape was recorded with Dolby NR.
 6. Set the REVERSE MODE selector buttons as desired.
 7. Press one of the ◀ PLAY ▶ buttons to start playback of the tape in the desired direction.
 8. Adjust the VOLUME controls to the desired volume level.
 9. Press the STOP button to stop tape playback when required.
 - The EQUALIZER switch may be turned ON () for desired frequency compensation.
 - The TAPE POSITION indicator which corresponds to the type of tape loaded in the cassette compartment will light up.
 - Slide the MIXING BALANCE control fully to the left.
- * The auto tape selector system will not function with cassettes which are not provided with special holes for triggering the metal tape position,

such as older tapes.

■ REVERSE MODE Selector Buttons

These selector buttons are used to change the direction of the tape transport during playback or recording.

⇄ Manual Mode (uni-directional)

In this mode, the tape will be recorded or played back in the forward or reverse direction only. When the tape end is reached during recording or playback, the full auto stop system will stop the tape transport.

↔ Auto Reverse Mode (bidirectional)

In this mode, the tape will first travel in the forward direction, and upon reaching the tape end, reverse the direction of tape travel and continue travelling to the end of the other side during recording or playback. When the tape end is reached during recording or playback in the reverse tape transport direction, the full auto stop system will stop the tape transport.

* If you want the tape to reverse during recording or playback in the bidirectional mode, the tape must be started in the forward tape transport mode. If the tape is started in the reverse tape transport mode, automatic reversing of the tape transport at the tape end will not take place.
* Before recording in the auto reverse mode, make sure the erasure prevention tabs on the cassette are not broken. If the tabs are broken, recording will not take place, or recording will stop at the end of forward tape transport without reversing the tape.

↻ Auto Reverse Repeat (continuous tape travel)

In this mode, the tape will automatically reverse direction whenever the tape end is reached both in the forward and reverse transport modes, for uninterrupted playback of both sides of the tape. Playback will continue until the STOP button is depressed.

If this mode is selected for recording, the unit will automatically stop the tape when the tape end is reached in the reverse tape transport mode.

■ Full Auto Stop System

The tape transport is automatically stopped when the tape end is reached during playback. This full auto stop system serves to protect your tapes against damage which might otherwise occur if the transport remains engaged at the end of a tape.

The full auto stop system works differently depending on the setting of the REVERSE MODE selector buttons:

REVERSE MODE selector button

⇄ depressed:

The tape is automatically stopped when all the tape has been taken up on one reel during playback, recording, fast forward or rewind.

REVERSE MODE selector button

↔ depressed:

The tape is automatically stopped when the tape end is reached in the reverse tape transport mode during recording or playback.

* During fast forward, rewind and YMS modes, the tape is always stopped automatically when a tape end is reached.

REVERSE MODE selector button

↻ depressed:

In the playback mode, the tape will travel continuously, without stopping at either tape end, until the STOP button is depressed.

In the recording mode, the tape is automatically stopped when the tape end is reached after reverse tape transport travel.

* During fast forward, rewind and YMS modes, the tape is always stopped automatically when a tape end is reached.

● NAMES OF THE PARTS AND THEIR FUNCTIONS ● DESCRIPTION DE LA FACADE ET DES COMMANDES ● BEZEICHNUNG DER TEILE UND DEREN FUNKTION ● NAMN PÅ DELARNA OCH DERAS FUNKTION ● NOMBRES DE LAS PARTES Y SUS FUNCIONES

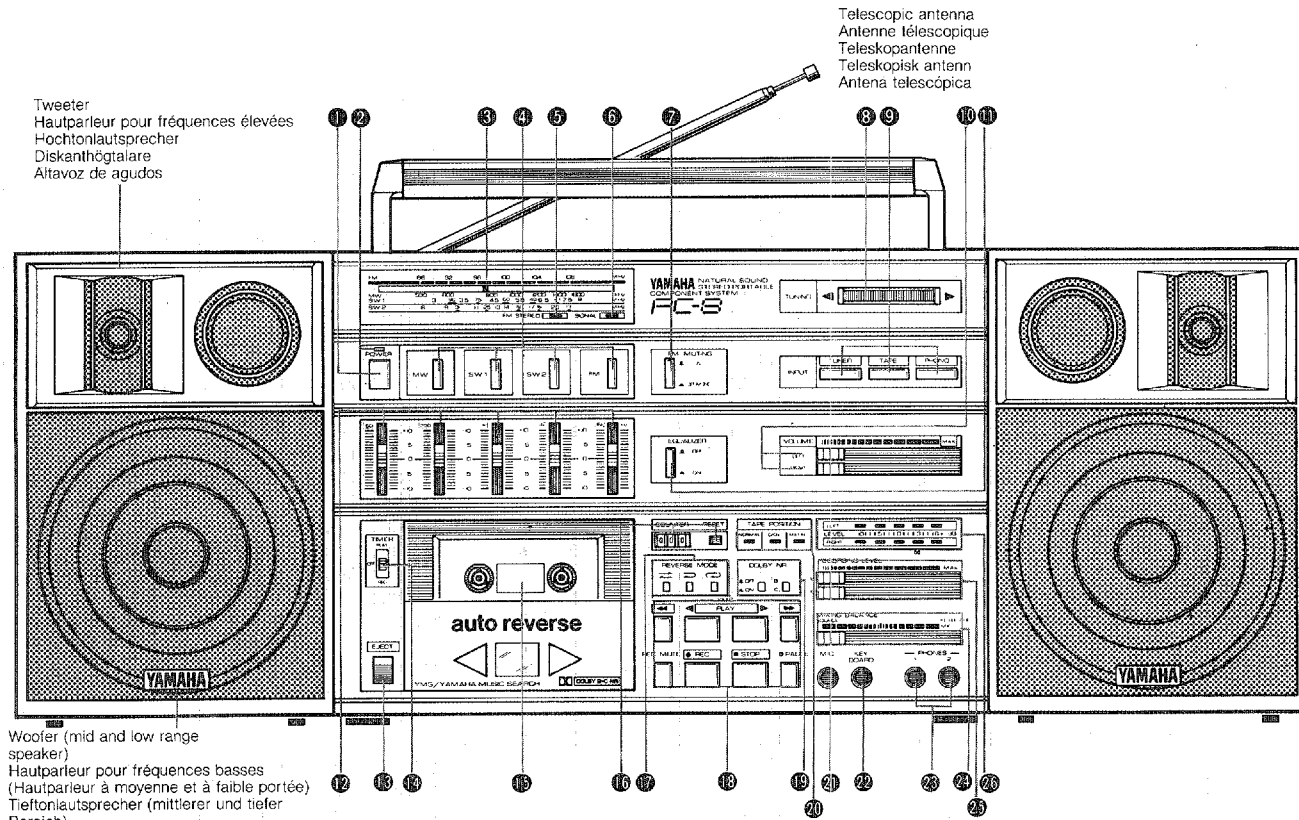

General Model

Tweeter
 Hautparleur pour fréquences élevées
 Hochtönlautsprecher
 Diskanthögtalare
 Altavoz de agudos

Telescopic antenna
 Antenne télescopique
 Teleskopantenne
 Teleskopisk antenn
 Antena telescópica

Woofer (mid and low range speaker)
 Hautparleur pour fréquences basses
 (Hautparleur à moyenne et à faible portée)
 Tieftönlautsprecher (mittlerer und tiefer Bereich)
 Bashögtalare (för mellanregister och bas)
 Altavoz de graves (gamas de tonos medios y bajos)

U.S.A. and Canadian Models

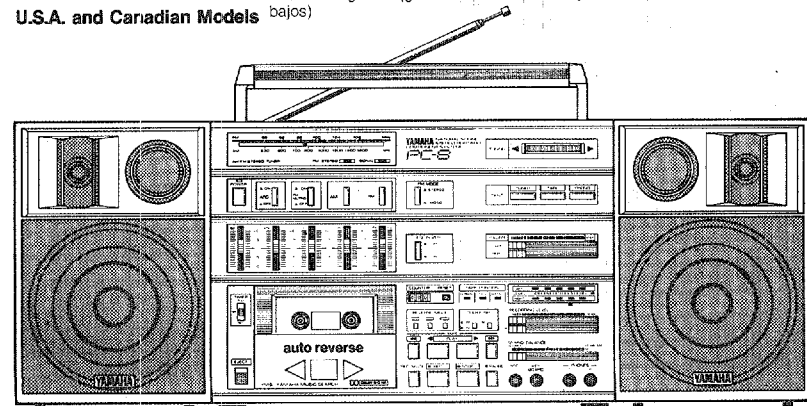

U.K. and European Models

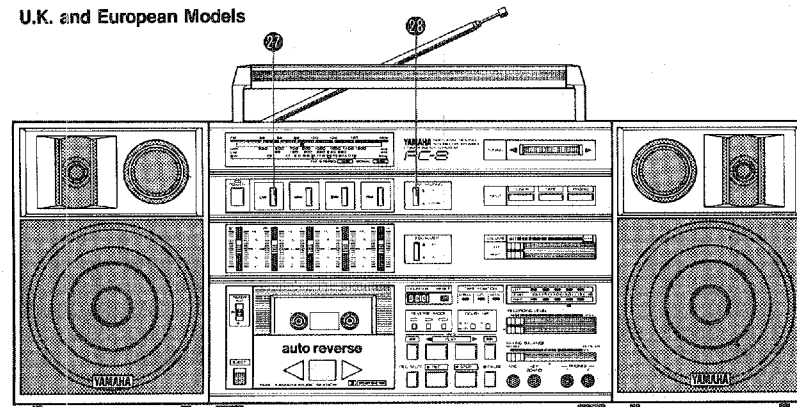

NAMES OF THE PARTS AND THEIR FUNCTIONS

1 POWER switch

Depress this switch once to turn the power ON, and depress again to turn the power OFF.

Prior to turning the power on, confirm that the VOLUME control is turned fully down.

2 POWER indicator

This indicator lights up when the power of the unit is turned on. The indicator will start flickering when the DC power source is exhausted.

3 Dial indicator

This indicator runs along the frequency scale as the TUNING dial knob (8) is turned, for a visual indication of the tuned-in station.

4 Band selectors

Includes selectors for the various reception bands, which differ according to area. Please refer to the section "Band Selector Switches According to Area". Depress the appropriate selector button for reception.

5 FM STEREO indicator

Lights up automatically to indicate FM stereo reception in the stereo mode. The indicator will not light up if the signal received is a monaural one.

Note: This indicator works only while the FM mode is engaged.

6 SIGNAL indicator

Lights up when a station is received. The indicator will light at its brightest when the station is optimally tuned in.

7 FM MUTING button

When this button is depressed to the ON (■) position in the FM mode, the muting circuit is engaged and all interstation noise is suppressed during tuning.

If the signal you want to tune in is a weak one, reset the button to the OFF/MONO (—) position and then tune in the desired station. (This

switch is FM Mode switch to the U.S. and Canada. See to 28)

Note: The FM muting circuit only works during FM reception.

8 TUNING dial knob

Used to tune in the desired station.

9 INPUT selector buttons
Used for choosing an input source.

10 VOLUME controls

Slide these controls to the right or left until the desired volume level of your speakers or headphones is obtained. The separate controls, upper and lower, are provided for the left and right channels respectively, so that sound level balancing between the two channels is possible.

11 EQUALIZER switch

Turning this switch to the ON (—) position enables the equalizer controls to be used to compensate for any inadequacies in the tone reproduced. The equalizer control function is disengaged by resetting this switch to the OFF (■) position, in which case a flat frequency response is achieved irrespective of the setting of the equalizer controls.

12 Equalizer controls

Used to compensate for inadequate tonal response of the reproduced sound. In the "0" position, a flat frequency response is achieved. Each control can be adjusted by up to +10 dB (3 times amplification) by sliding it upwards towards + and by -10 dB (1/3 amplification) by sliding it downwards towards (-). Control of separate frequencies is possible for the following frequencies: 60 Hz, 250 Hz, 1 kHz, 4 kHz, and 16 kHz, so as to enable adjustment over a wide frequency range. This also provides the advantage of achieving a richer sound as well as removing noise such as tape hiss.

13 EJECT button

This button is used to open the cassette compartment when the tape is not running.

14 TIMER switch

This switch is used in conjunction with an optional audio timer for automatic playback or recording at a preset time.

PLAY: The unit will start playback automatically at a preset time. This function may serve as a musical alarm clock.

REC: The unit will start recording of a preselected radio station at a preset time.

Note: When the timer function is not used, be sure to set the TIMER switch to the OFF position.

If the POWER switch is turned ON while the TIMER switch is in the REC position, the unit will automatically start recording, erasing previously recorded material on the tape.

15 Cassette compartment

Holds the tape in position for playback or recording.

16 REVERSE MODE selector buttons

Used to select the reverse mode. For detailed information on the REVERSE MODE selector buttons, refer to the section entitled "REVERSE MODE Selector Buttons".

17 Tape COUNTER & RESET button

Press the RESET button to reset the COUNTER to "000". The tape COUNTER provides you with a measurable indication of tape travel.

18 Tape transport controls

◀◀: Press this button to wind the tape in the direction of the double arrow symbol. Pressing this button during playback activates the YMS (Yamaha Music Search) system.

◀ PLAY ▶: Press one of these buttons for playback in one of the directions indicated by the arrows. The indicator above the button pressed lights up to indicate the tape transport direction.

▶▶: Press this button to wind the tape in the direction of the double

arrow symbol. Pressing this button during playback activates the YMS (Yamaha Music Search) system.

REC MUTE: While this button is pressed during recording, the tape will continue to run but nothing will be recorded.

REC: Press this button simultaneously with one of the ◀ PLAY ▶ buttons to start recording. The indicators above the buttons will light up.

STOP: Press this button to stop the tape while in Recording, Playback, Fast Forward or Rewind mode.

* Stop mode is automatic when the tape ends in any mode (auto-stop mechanism).

PAUSE: When this button is pressed, the Rec Standby mode will be engaged, and the REC indicator will light. While in this mode, the recording level meters will operate, allowing you to set the proper level before starting to record.

19 DOLBY NR switches

The left switch is used to turn the Dolby NR system ON (—) or OFF (■).

The right switch is used for selection of B (■) or C (—) type Dolby NR. If the tape has been recorded with Dolby B type NR it should also be played back with the Dolby B type NR system. Similarly, if the tape has been recorded with Dolby C type NR, it should be played back with the Dolby C NR system. If the tape has been recorded without Dolby Noise Reduction, the left switch should be set to the OFF position at time of playback.

* Dolby and the double D mark are trademarks of Dolby Laboratories Licensing Corporation. Dolby noise reduction system manufactured under license from Dolby Laboratories Licensing Corporation.

20 Tape select switch (TAPE POSITION)

When a cassette tape is loaded in the

cassette compartment, the built-in detector will automatically set the correct tape position according to the type of tape being used.

Note: When the POWER switch is turned On and no tape is loaded, the METAL position indicator lights up.

21 Microphone input jack (MIC)

For connection of a microphone plug. When a microphone is not being used, disconnect the plug from the jack.

22 KEYBOARD jack

For connection of the plug from a keyboard instrument. When a keyboard instrument is not used, disconnect the plug from the jack.

23 Headphones jacks (PHONES)

Provided for private listening through stereo headphones. When headphones are connected to one or both of the PHONES jacks, the speakers are automatically disconnected.

24 MIXING BALANCE control

When this control is slid fully to the right, only the sound from the connected microphone or keyboard instrument can be heard.

25 RECORDING LEVEL controls

The upper and lower controls can be slid left or right to adjust the recording input level for the left and right channels respectively. The recording levels are indicated on the LEVEL indicators 26.

26 LEVEL indicators

Indicate the level of recording or playback sound.

27 Auto Frequency Control button

(only on U.S. and Canadian models) This button is used to make automatic frequency adjustment for the best possible FM reception.

28 FM MODE switch (only on U.S. and Canadian models)

This switch sets the FM listening mode of the unit. When the switch is turned on, stereo or monaural signals can be selected using the STEREO/MONO mode switch. If the signal is

weak in the STEREO mode, select the MONO mode to improve reception.

YMS (Yamaha Music Search) System

The YMS system operates by detecting the blank space between selections on a tape so that you can accurately select music selections right from the beginning.

This system allows you to select and play selections automatically in both the forward and reverse directions. The example which follows explains music search in the forward direction only. In order to change to reverse selection, just press the button opposite to the one in the example. For example, where the description refers to playback (▶), fast forward (▶▶) or rewind (◀◀) you should change to playback (◀), fast forward (▶▶) and rewind (▶▶) respectively.

YMS Operation

* To repeat the selection you are presently listening to:

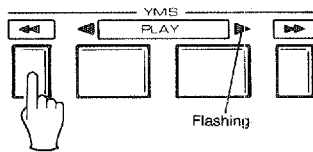

Press the ◀◀ button in the playback mode.

The PLAY indicator starts flashing and the tape is rewound and stops at the desired selection. Playback then starts automatically.

When you want to locate a particular selection several selections back on the tape, repeat the above process the number of times equivalent to the number of blank spaces in between the unwanted selections until you reach the desired selection.

* To skip the present selection and continue playback from the following one.

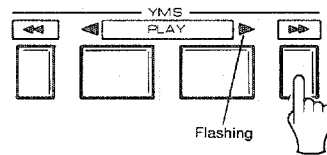

Press the ▶▶ button in the playback mode.

The PLAY indicator starts flashing and the tape is fast forwarded and stops at the desired selection. Playback then starts automatically. When you want to locate a particular selection several selections ahead on the tape, repeat the above process the number of times equivalent to the number of blank spaces in between the unwanted selections until you reach the desired selection.

Note:

* Depending on the setting of the VOLUME controls, a squeaking sound may be heard through the speakers during YMS operation.

* The YMS system works by detecting the blank, unrecorded sections in between selections recorded on a tape. These blank spaces must be of sufficient length in order for The YMS system to work properly. The YMS system may not work correctly with some tape recordings in the following cases:

1. Voice recordings with pauses in the conversation.
2. Music tapes on which there are relative long intervals of silence in the recording or on which pianissimo is present for an extended period of time.
3. Music tapes recorded with very low recording levels.
4. Tapes with less than 4 second intervals between the selections.
5. Tape recordings with excessive noise or hum in the blank spaces.

MICROPHONE MIXING

With the PC-8, mixing operation using a microphone and/or a keyboard instrument is possible.

* Follow the steps below.

- 1) Turn ON the POWER switch.
- 2) Tune in the desired radio program or start playback of the record as previously explained.
- 3) Connect the microphone to the MIC jack.
- 4) Adjust the MIXING BALANCE control for optimum balance between the microphone and the program source.
- 5) Adjust the VOLUME controls to the desired volume level.

- The EQUALIZER switch may be turned ON () for desired frequency compensation.
- Connect a keyboard instrument to the KEYBOARD jack.
- The applicable microphone input impedance is from 200 ohms to 10 k-ohms.
- When the mixing operation involves a keyboard instrument, the sound level of the instrument may be adjusted through the volume control of the instrument itself.

• MIC jack and KEYBOARD jack

Both a microphone and a keyboard instrument can be connected to the PC-8 for simultaneous mixing. The results of the mixing operation may also be recorded on tape. Connect the microphone to the MIC jack.

Connect the keyboard instrument to the KEYBOARD jack. (If you intend to connect other electrical instruments, these should have a high output to match the mixing operation on the PC-8.)

Mixing output is produced equally from the left and right channels in monaural.

* The connection of a keyboard instrument during mixing with a

microphone results in a reduction in sound level from the microphone. In such a case, adjust the MIXING BALANCE control and the volume control on the connected instrument. * When only a microphone and/or a keyboard instrument is connected to the PC-8 for playback or recording of the reproduced sound, push the button not used for the INPUT selector.

* Raising the microphone output level or holding the microphone near the speakers during mixing may produce howling.

* No connections should be made to the MIC and KEYBOARD jacks other than during mixing operation.

• Adjustment of the MIXING BALANCE control

* The MIXING BALANCE control sets the balance between the program source and the output from the microphone and/or keyboard instrument connected for mixing operation. The sound level from the microphone and/or keyboard instrument is increased by sliding the MIXING BALANCE control to the right towards "KEYBOARD/MIX", and the program source sound level is increased by sliding the control to the left towards "SOURCE".



- ① The sound level of the program source increases.
- ② The sound level from the connected microphone and/or keyboard instrument increases.

* When the unit is operated for playback or recording of the inputs from a connected microphone and/or keyboard instrument only, and mixing operation is not required, slide the MIXING BALANCE control fully to the

right to the "KEYBOARD/MIC" end position.

* When not mixing, slide the MIXING BALANCE control fully to the left to the "SOURCE" end position.

RECORDING

Recording from a record

* Follow the steps below.

1. Make sure that the TIMER switch is set to the OFF position.

2. Turn ON the POWER switch.

3. Insert a cassette tape into the cassette compartment.

4. Press the RESET button to reset the COUNTER to "000".

5. Set the DOLBY NR switch to ON or OFF as desired. If the DOLBY NR switch is set to ON, select B-type or C-type Dolby noise reduction.

6. Press the desired REVERSE MODE selector button.

7. Press the PAUSE button. (Note that the PAUSE indicator lights up.)

8. Press the PHONO INPUT selector button, and start playback of the record.

9. Press the REC button and one of the ◀ PLAY ▶ buttons simultaneously. When pressing the PLAY button, choose forward or reverse recording accordingly.

* This sets the unit in the recording standby mode, causing the REC indicator to light up.

10. Adjust the RECORDING LEVEL controls as desired.

11. Start record playback from the beginning, after the recording levels have been set, and press the PAUSE button once more to start recording.

• The EQUALIZER switch may be turned ON (—) for desired frequency compensation. The equalizer adjustment does not affect recording.

• Adjustment of this control may be done as desired, as this does not affect recording.

• Tape counter

The tape COUNTER provides a digital indication of the distance the tape has travelled. When recording from the beginning of a tape, set the COUNTER to "000" by pressing the RESET button. As you record various selections on the tape, write down the indicated number on the COUNTER at the beginning of each selection. When the tape is played back later on, you can quickly locate the desired selection by winding the tape to the corresponding number for that selection shown on the COUNTER.

• Recording Level Adjustment

* The optimum recording level is achieved when the RECORDING LEVEL control for each channel is set so that the LEVEL indicators light up to a maximum of +3 dB at the highest volume levels in the program source.

* Differences in the recording levels of the left and right channels can be corrected by independent adjustment of the upper (L — left channel) and lower (R — right channel) RECORDING LEVEL controls.

- ① Maximum +3 dB
- ② Left channel (L)
- ③ Right channel (R)

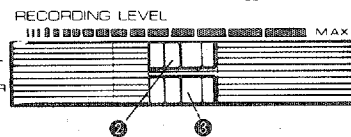
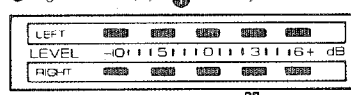

RECORDING BROADCAST RECEPTIONS

* Follow the steps below.

1. Follow steps 1 through 7 as explained in the section on "Recording from a record".

2. Press the TUNER button of the INPUT selector buttons, and tune in the desired station according to the previous instructions on tuning operation.

3. Press the REC button and one of the ◀ PLAY ▶ buttons simultaneously. When pressing the PLAY button, choose forward or reverse recording accordingly.

* This sets the unit in the recording standby mode, causing the REC indicator to light up.

4. Adjust the RECORDING LEVEL controls as desired.

5. Press the PAUSE button once more to start recording.

• While recording from the program source, the REC MUTE button may be pressed to record a blank space on the tape.

• The BEAT switch on the back of the unit has two positions: "1" and "2". When recording from an MW (AM) broadcast, a beat sound may sometimes be heard. In such a case, simply set the BEAT switch to the other position to cancel the beat noise.

REC MUTE SWITCH

During recording, press this button to record a blank space on the tape.

The REC MUTE button is convenient for excluding commercial messages or sections you do not want to

record, or to create blank spaces between the selections in order for the YMS system to work properly during playback.

Operation of the REC MUTE button for creating blank spaces for the YMS system:

1. Press the REC MUTE button and keep it depressed for approximately 4 to 5 seconds when you reach the end of the selection you are recording. The YMS system only works if the blank spaces in between music selections are 4 to 5 seconds long.

2. With the REC MUTE button depressed, press the PAUSE button. Then release the REC MUTE button.

3. When the next program you want to record starts, press the PAUSE button once more to re-start recording.

* Please refer to the section on "Band Selector Switches According to Area".

MIXING RECORDING

1. Proceed with mixing operation as previously explained, including adjustment of the MIXING BALANCE and RECORDING LEVEL controls.

2. Start recording following the procedures for recording and mixing simultaneously.

* To record the results of the mixing operation on an external tape deck, connect that deck as shown in the connection diagram.

The playback sound of the tape in PC-8 cannot be copied back onto the same tape.

* Raising the sound level too much or holding the microphone too near the speakers may produce howling during recording.

TIMER OPERATION

Unattended Recording and Wake-Up Playback.

Unattended recording and wake-up playback is possible with the PC-8 when connected to an external audio timer. This permits automatic playback or recording at a preset time.

* Unattended Recording

1. Following the instructions in the section entitled "Broadcast Reception", tune in the desired station and adjust the RECORDING LEVEL controls.

2. Set the timer SWITCH to the REC position.

3. Preset the time on the timer to the

time the desired program will be broadcast.

It is preferable to set the preset time slightly ahead of the actual time to compensate for any discrepancy between the preset time and actual time.

* For timer operation, refer to the owner's manual of the timer to be used.

4. At the preset time, power to the unit is turned on and recording of the program begins.

* During timer operation, the unit will automatically start tape transport in the forward direction.

* Wake-Up Playback

1. Following the instructions in the section entitled "Tape Playback", set the unit to playback of a desired selection, and adjust the VOLUME controls as desired.

2. Set the TIMER switch to the PLAY position.

3. Preset the time on the timer to the time you want the playback to start.

4. At the preset time, power to the unit will turn on and playback will start automatically.

Cleaning the Tape Heads

Deterioration of sound reproduction on cassette tapes or distortion in the recorded sound usually indicates dirty heads and/or pinch roller.

Clean the heads, capstan and pinch roller and magnetization of the heads. (more frequently when using metal tapes).

Demagnetizing the Heads

When the heads are excessively magnetized, deterioration of high frequency reproduction and excessive noise will occur. In such a case, demagnetize the heads using a commercially available head demagnetizer.

GRABACION CON MEZCLA DE SONIDO

1. Proceda con la operación de mezcla de la forma descrita en la sección correspondiente, incluyendo el ajuste de los mandos de equilibrio de mezcla (MIXING BALANCE) y del nivel de grabación (RECORDING LEVEL).

2. Comience a grabar siguiendo simultáneamente los procedimientos de grabación y de mezcla de sonido.

* Para grabar la mezcla de sonido en una platina de cinta externa, conecte dicha platina de la forma mostrada en el esquema de conexiones.

La reproducción de la cinta del PC-8 no puede copiarse de nuevo en la misma cinta.

* Puede producirse realimentación acústica por las pantallas si se sube demasiado el nivel de sonido o si se acerca el micrófono a las pantallas.

MANEJO CON TEMPORIZADOR

Grabación estando ausente y reproducción para despertarse. Es posible grabar programas estando ausente o despertarse con música cuando el PC-8 esté conectado a un temporizador de audio opcional. Este aparato permite la reproducción o la grabación automáticas a la hora preajustada.

* Grabaciones en ausencia

1. Siga las instrucciones descritas en "Recepción de la Radio", sintonice la emisora deseada y ajuste los mandos del nivel de grabación (RECORDING LEVEL).

2. Ponga el interruptor del temporizador (TIMER) en la posición REC.
3. Preajuste la hora de comienzo del programa de radio que desea grabar. Es preferible ajustar la hora un poco antes de la hora real para compensar cualquier discrepancia que pudiera

producirse entre ambas.

* Consulte el manual de instrucciones del temporizador para conocer su manejo correcto.

4. A la hora preajustada, se alimentará energía a la unidad y comenzará a grabarse el programa de radio deseado.

* Durante el funcionamiento del temporizador, la unidad automáticamente podrá en marcha el transporte de la cinta en el sentido de avance normal.

* Para despertarse con música

1. Siga las instrucciones descritas en la sección "Reproducción de cintas", ponga la unidad en el modo de reproducción y ajuste el volumen con los mandos de volumen (VOLUME).

2. Ponga el interruptor del temporizador (TIMER) en la posición PLAY.

3. Ajuste la hora a la que desea despertarse en el temporizador.
4. A la hora preajustada, se alimentará energía a la unidad y comenzará automáticamente la reproducción.

Limpieza de las cabezas de cinta

Si el sonido de reproducción de las cintas cassette empeora o si se distorsiona el sonido grabado, generalmente es una indicación de que las cabezas y/o el rodillo presor están sucios. Limpie las cabezas, eje de arrastre y rodillo presor periódicamente (con más frecuencia cuando se usen cintas de metal) y desimante las cabezas.

Cómo desimantar las cabezas

Cuando las cabezas se hayan imantado excesivamente, se deteriorará la reproducción de los tonos altos y se escucharán ruidos excesivos. En tal caso, desimante las cabezas usando un desimantador de cabezas corriente puesto a la venta en los establecimientos del ramo.

SPECIFICATIONS

Band and Frequency Range According to Area

	FM (MHz)	MW (kHz)	LW (kHz)	SW (MHz)	SW ₁ (MHz)	SW ₂ (MHz)
U.S.A. and Canada	87.6—108.0	525—1605	—	—	—	—
Europe and U.K.	87.6—108.0	525—1605	153—280	5.8—16.0	—	—
Australia and Other Areas	87.6—108.0	525—1605	—	—	3.0—8.0	8.0—22.0

TUNER SECTION

FM Section

Usable Sensitivity (30 dB S/N, 300 ohms):

2.5 μ V/13.8 dB

Signal-to-Noise Ratio (mono): 65 dB

Harmonic Distortion (mono, 1 kHz): 0.3%

Image Response Ratio: 50 dB

Frequency Response: 30—10,000 Hz \pm 1.5 dB

MW Section

Usable Sensitivity (20 dB S/N, bar antenna):

250 μ V/m

Signal-to-Noise Ratio: 45 dB

Image Response Ratio: 50 dB

LW Section

Usable Sensitivity (20 dB S/N, bar antenna):

250 μ V/m

Signal-to-Noise Ratio: 45 dB

SW (5.8—16.0 MHz) Section

Usable Sensitivity (20 dB S/N): 20 μ V

Signal-to-Noise Ratio: 45 dB

SW₁ (3.0—8.0 MHz) Section

Usable Sensitivity (20 dB S/N, bar antenna):

250 μ V/m

Signal-to-Noise Ratio: 45 dB

SW₂ (8.0—22.0 MHz) Section

Usable Sensitivity (20 dB S/N): 20 μ V

Signal-to-Noise Ratio: 45 dB

CASSETTE DECK SECTION

Track Configuration: 4 track, 2 channel stereo

Motor: 3 DC motors (capstan, reel and head)

Head: Super hard Permalloy rec/playback head:

Ferrite erase head

FF/REW Time: 70 sec (C-60)

Wow and Flutter: 0.05% (WRMS)

Signal-to-Noise Ratio (Metal Tape)

Dolby C NR On: 71 dB

Dolby B NR On: 63 dB

Dolby NR Off: 55 dB

Crosstalk: 50 dB

Frequency Response

Normal Tape: 20—15,000 Hz \pm 3 dB

CrO₂ Tape: 20—16,000 Hz \pm 3 dB

Metal Tape: 20—17,000 Hz \pm 3 dB

AMP SECTION

Peak Music Power Output: 50 W

RMS Output Power:

13 W + 13 W (DC, 1 kHz, 10% THD, 4 ohms)

15 W + 15 W (AC, 1 kHz, 10% THD, 4 ohms)

Minimum RMS Output Power per Channel:

13 W + 13 W (DC, 50 to 20,000 Hz, 10% THD, 4 ohms)

15 W + 15 W (AC, 50 to 20,000 Hz, 10% THD, 4 ohms)

Input Sensitivity/Impedance

Keyboard: 150 mV/50 k-ohms

Mic (mono): 0.5 mV/10 k-ohms

Signal-to-Noise Ratio: 75 dB

Frequency Response: 20—30,000 Hz \pm 3 dB

Impedance: 4 ohms

SPEAKER SECTION

Type: 2-way, bass reflex

Woofer: 12 cm (4-3/4") cone

Tweeter: 3 cm (1-3/16") ceramic dome

Impedance: 4 ohms

GENERAL

Power Supply (AC)

U.S.A. and Canada: 120 V/60 Hz

Europe: 220 V/50 Hz

U.K. and Australia: 240 V/50 Hz

Other Areas: 110/120/220/240V, 50/60 Hz

Power Supply (DC): 15 V (D or R20 batteries x 10)

Total Dimensions (WxHxD): 675x246x207 mm

(26-5/8" x 10-3/8" x 8-1/8")

PC-8 Dimensions (WxHxD): 340x246x203 mm

(13-3/8" x 10-3/8" x 8")

(Speaker Systems) Dimensions (WxHxD):

165x246x207 mm

(6-1/2" x 9-3/4" x 8-1/8")

Weight: 12 kg (26 lbs. 6 oz.) without batteries

Specifications subject to change without notice.

SPECIFICATIONS

Gammes de fréquence et d'ondes selon le pays

	MF (MHz)	OM (kHz)	GO (kHz)	OC (MHz)	SW ₁ (MHz)	SW ₂ (MHz)
U.S.A. et Canada	87,6— 108,0	525— 1605	—	—	—	—
Europe et Royaume-Uni	87,6— 108,0	525— 1605	153— 280	5,8— 16,0	—	—
Australie et autres pays	87,6— 108,0	525— 1605	—	—	3,0— 8,0	8,0— 22,0

SECTION TUNER

Section FM

Sensibilité utile (30 dB S/N, 300 OHMS):

2,5 µV/13,8 dB

Rapport signal/bruit (mono): 65 dB

Distorsion harmonique (mono, 1 kHz): 0,3%

Réjection fréquence image: 50 dB

Réponse en fréquence: 30—10.000 Hz ± 1,5 dB

Section OM

Sensibilité utile (20 dB S/N, antenne barre):

250 µV/m

Rapport signal/bruit: 45 dB

Réjection fréquence image: 50 dB

Section GO

Sensibilité utile (20 dB S/N, antenne barre):

250 µV/m

Rapport signal-bruit: 45 dB

Section OC (5,8—16,0 MHz)

Sensibilité utile (20 dB S/N): 20 µV

Rapport signal-bruit: 45 dB

Section SW₁ (3,0—8,0 MHz)

Sensibilité utile (20 dB S/N): 250 µV/m

Rapport signal-bruit: 45 dB

Section SW₂ (8,0—22,0 MHz)

Sensibilité utile (20 dB S/N): 20 µV

Rapport signal-bruit: 45 dB

SECTION PLATINE DE CASSETTE

Disposition des pistes: 4 pistes/2 canaux stéréo

Moteur: 3 moteurs cc (cabestan, bobinage et

tête)

Tête: Tête enr/playback en ferro-nickel super

résistant

Tête d'effacement en ferrite

Bobinage avant/arrière: 70 s pour C60

Pleurage et scintillement: 0,05% (WRMS)

Rapport signal/bruit (branda METAL)

Type C avec Dolby en service: 71 dB

Type B avec Dolby en service: 63 dB

Avec Dolby hors service: 55 dB

Puissance perturbatrice: 50 dB

Réponse en fréquence

Bande normale: 20—15 000 Hz ± 3 dB

Bande CrO₂: 20—16 000 Hz ± 3 dB

Bande métal: 20—17 000 Hz ± 3 dB

SPEZIFIKATIONEN

Band- und Frequenzbereich entsprechend dem Gebiet

	UKW (MHz)	MW (kHz)	LW (kHz)	KW (MHz)	SW ₁ (MHz)	SW ₂ (MHz)
U.S.A. und Kanada	87,6— 108,0	525— 1605	—	—	—	—
Europa und Groß- britannien	87,6— 108,0	525— 1605	153— 280	5,8— 16,0	—	—
Australien und andere Gebiete	87,6— 108,0	525— 1605	—	—	3,0— 8,0	8,0— 22,0

TUNER-Teil

UKW-Empfangsteil

Eingangsempfindlichkeit (30 dB S/N, 300 Ohm):

2,5 µV/13,8 dB

Fremdspannungsabstand (Mono): 65 dB

Klirrfaktor (Mono, 1 kHz): 0,3%

Spiegelfrequenzunterdrückung: 50 dB

Frequenzgang: 30—10.000 Hz ± 1,5 dB

MW-Empfangsteil

Eingangsempfindlichkeit (20 dB S/N,

Stabantenne): 250 µV/m

Fremdspannungsabstand: 45 dB

Spiegelfrequenzunterdrückung: 50 dB

LW-Empfangsteil

Eingangsempfindlichkeit (20 dB S/N,

Stabantenne): 250 µV/m

Fremdspannungsabstand: 45 dB

SW (5,8—16,0 MHz)-Empfangsteil

Eingangsempfindlichkeit (20 dB S/N): 20 µV

Fremdspannungsabstand: 45 dB

SW₁ (3,0—8,0 MHz)-Empfangsteil

Eingangsempfindlichkeit (20 dB S/N,

Stabantenne): 250 µV/m

Fremdspannungsabstand: 45 dB

SW₂ (8,0—22,0 MHz)-Empfangsteil

Eingangsempfindlichkeit (20 dB S/N): 20 µV

Fremdspannungsabstand: 45 dB

CASSETTENECKTEIL

Spuranordnung: 4-Spur, 2-Kanal-Stereo

Motor: 3 Gleichstrommotoren (Bandtransportrolle,

Spule und Tonkopf)

Tonkopf: Superhartes Permetall Aufnahme/

Wiedergabekopf; Ferrit-Löschkopf

FF/REW-Zeit: 70 s (C-60)

Bandgeschwindigkeitsschwankungen: 0,05%

(WRMS)

Fremdspannungsabstand (Metallband)

Dolby-C-NR ON: 71 dB

Dolby-B-NR ON: 63 dB

Dolby-NR-OFF: 55 dB

Übersprechen: 50 dB

Frequenzgang

Normal Band: 20—15.000 Hz ± 3 dB

CrO₂ Band: 20—16.000 Hz ± 3 dB

Metallband: 20—17.000 Hz ± 3 dB

VERSTÄRKERTEIL

Spitzenmusikleistung: 50 W

RMS Ausgangsleistung:

13 W + 13 W (Gleichstrom, 1 kHz, 10%

Klirrfaktor, 4 Ohm)

15 W + 15 W (Wechselstrom, 1 kHz, 10%

Klirrfaktor, 4 Ohm)

Minimum RMS Ausgangsleistung pro Kanal:

13 W + 13 W (Gleichstrom, 50 bis 20.000 Hz,

10% Klirrfaktor, 4 Ohm)

15 W + 15 W (Wechselstrom, 50 bis 20.000 Hz,

10% Klirrfaktor, 4 Ohm)

Eingangsempfindlichkeit/Impedanz

Tasteninstrument: 150 mV/50 k-Ohm

Mikrofon (Mono): 0,5 mV/10 k-Ohm

Fremdspannungsabstand: 75 dB

Ausgangsleistung pro Kanal: 10%

(Wechselstrom/Gleichstrom, 10% THD,

4 Ohm)

Frequenzgang: 20—30.000 Hz, ± 3 dB

LAUTSPRECHER

Typ: 2-Weg, Bassreflex

Tieftonlautsprecher: 12 cm

Trichterlautsprecher

Hochtonlautsprecher: 3 cm

Kalottenlautsprecher

Impedanz: 4 Ohm

ALLGEMEINES

Netzanschluß (Wechselstrom)

U.S.A. und Kanada: 120 V/60 Hz

Europa: 220 V/50 Hz

Großbritannien und Australien: 240 V/50 Hz

Andere Gebiete:

110/120/220/240V, 50/60 Hz

Netzanschluß (Gleichstrom):

15 V (D oder R20-Batterien x 10)

Abmessungen (BxHxT): 675x246x207 mm

PC-8-Abmessungen (BxHxT): 340x246x203 mm

Abmessungen des Lautsprechersystems

(BxHxT): 165x246x207 mm

Gewicht: 12 kg ohne Batterien

Technische Änderungen ohne Vorankündigung

jederzeit vorbehalten.

SPECIFIKATIONER

Frekvensband och avstämningsfrekvenser för olika områden:

	FM (MHz)	MV (kHz)	LV (kHz)	KV ₁ (MHz)	KV ₂ (MHz)
U.S.A. och Kanada	87,6—108,0	525—1605	—	—	—
Europa och Storbritannien	87,6—108,0	525—1605	153—280	5,8—16,0	—
Australien och andra områden	87,6—108,0	525—1605	—	—	8,0—22,0

TUNERDELEN

FM delen

Känslighet (30 dB signalbrusförhållande, 300 ohm): 2,5 μ V/13,8 dB
Signalbrusförhållande (mono): 65 dB
Harmonisk distorsion (mono, 1 kHz): 0,3%
Spegelfrekvensundertryckning: 50 dB

MV delen

Känslighet (20 dB signalbrusförhållande, stavantenn): 250 μ V/m
Signalbrusförhållande: 45 dB
Spegelfrekvensundertryckning: 50 dB

LV delen

Känslighet (20 dB signalbrusförhållande, stavantenn): 250 μ V/m
Signalbrusförhållande: 45 dB

KV delen (5,8—16,0 MHz)

Känslighet (20 dB signalbrusförhållande): 20 μ V

Signalbrusförhållande: 45 dB

KV₂ (3,0—8,0 MHz)

Känslighet (20 dB signalbrusförhållande, stavantenn): 250 μ V/m

Signalbrusförhållande: 45 dB

KV₁ delen (8,0—22,0 MHz)

Känslighet (20 dB signalbrusförhållande): 20 μ V

Signalbrusförhållande: 45 dB

KASSETTDÄCKSELEN

Spårssystem: 4-spårs, 2-kanals stereosystem

Motorer: 3 likströmsmotorer (drivrulle, spolar och bandhuvuden)

Bandhuvuden: Superhårt Permalloy in-/avspelningshuvud, raderingshuvud i ferrit

Snabbspolningstid: 70 sekunder (C-60)

Svaj: 0,05% (WRMS)

Signalbrusförhållande (metallband)

Dolby C — 71 dB

Dolby B — 63 dB

Dolby från — 55 dB

Överhörning: 50 dB

Frekvensåtergivning

Normalband: 20—15.000 Hz \pm 3 dB

CrO₂ band: 20—16.000 Hz \pm 3 dB

Metallband: 20—17.000 Hz \pm 3 dB

FÖRSTÄRKARDELEN

Toppmusikeffekt: 50 W

Uteffekt (RMS):

13 W + 13 W (likström, 1 kHz, 10% total harmonisk distorsion, 4 ohm)
15 W + 15 W (växelström, 1 kHz, 10% total harmonisk distorsion, 4 ohm)

Minimum uteffekt per kanal (RMS):

13 W + 13 W (likström, 50 till 20.000 Hz, 10% total harmonisk distorsion, 4 ohm)
15 W + 15 W (växelström, 50 till 20.000 Hz, 10% total harmonisk distorsion, 4 ohm)

Ineffekt-känslighet/impedans

Synthesizer: 150 mV/50 kohm

Mikrofon (mono): 0,5 mV/10 kohm

Signalbrusförhållande: 75 dB

Märkuteffekt per kanal:

10 W (växelström/likström, 10% total harmonisk distorsion, 4 ohm)

Frekvensåtergivning: 20—30.000 Hz, \pm 3 dB

HÖGTALARNA

Typ: 2-vägs, basreflexhögtalare

Baselement: 12 cm kon

Diskantelement: 3 cm keramisk kupolmembran

Impedans: 4 ohm

ALLMÄNT

Effektbehov — växelström

U.S.A. och Kanada: 120 V, 60 Hz

Europa: 220 V, 50 Hz

Storbritannien och Australien: 240 V, 50 Hz

Andra områden: 110/120/220/240V, 50/60 Hz

Effektbehov — likström: 15 V likström

(10 batterier av typ D eller R20)

Totala yttermått (BxHxD): 675x246x207 mm

PC-8:s yttermått (BxHxD): 340x246x203 mm

(huvudapparat endast)

Högtalarnas yttermått (BxHxD):

165x246x207 mm

Rätten till ändringar i specifikationen förbehålls.

ESPECIFICACIONES

Bandas y gamas de frecuencias según las regiones

	FM (MHz)	OM (kHz)	OL (kHz)	OC (MHz)	OC ₁ (MHz)	OC ₂ (MHz)
EE. UU. y Canadá	87,6—108,0	525—1605	—	—	—	—
Europa y Reino Unido	87,6—108,0	525—1605	153—280	5,8—16,0	—	—
Australia y otras regiones	87,6—108,0	525—1605	—	—	3,0—8,0	8,0—22,0

SECCION DEL SINTONIZADOR

Sección de FM

Sensibilidad utilizable (30 dB S/R, 300 ohmios): 2,5 μ V/13,8 dB

Relación señal-ruido (mono): 65 dB

Distorsión armónica (mono, a 1 kHz): 0,3%

Razón de respuesta de imagen: 50 dB

Respuesta de frecuencias:

30—10.000 Hz \pm 1,5 dB

Sección de OM

Sensibilidad utilizable (20 dB S/R, antena de barra): 250 μ V/m

Relación señal-ruido: 45 dB

Razón de respuesta de imagen: 50 dB

Sección de OL

Sensibilidad utilizable (20 dB S/R, antena de barra): 250 μ V/m

Relación señal-ruido: 45 dB

Sección de OC (5,8—16,0 MHz)

Sensibilidad utilizable (20 dB S/R): 20 μ V

Relación señal-ruido: 45 dB

Sección de OC₁ (3,0—8,0 MHz)

Sensibilidad utilizable (20 dB S/R, antena de barra): 250 μ V/m

Relación señal-ruido: 45 dB

Sección de OC₂ (8,0—22,0 MHz)

Sensibilidad utilizable (20 dB S/R): 20 μ V

Relación señal-ruido: 45 dB

SECCION DE LA PLATINA DE CASSETTE

Configuración de pistas: 4 pistas, 2 canales estéreo

Motores: 3 motores de CC (en eje de arrastre, carrete y cabeza)

Cabezas: Cabeza de grabación y reproducción de Permalloy superduro; cabeza de borrado de ferrita.

Tiempo de bobinado y de rebobinado: 70 seg. (con cinta C-60)

Fluctuación y ululación (WRMS): 0,05%

Relación señal-ruido (con cinta de metal)

Con Dolby C: 71 dB

Con Dolby B: 63 dB

Sin Dolby: 55 dB

Diatonía: 50 dB

Respuesta de frecuencias

Cinta normal: 20—15.000 Hz \pm 3 dB

Cinta CrO₂: 20—16.000 Hz \pm 3 dB

Cinta de metal: 20—17.000 Hz \pm 3 dB

SECCION DEL AMPLIFICADOR

Potencia musical de pico: 50 vatios

Potencia RMS:

13 W + 13 W (CC, 1 kHz, 10% DAT, 4 ohmios)

15 W + 15 W (CA, 1 kHz, 10% DAT, 4 ohmios)

Potencia mínima RMS por canal:

13 W + 13 W (CC, 50 a 20.000 Hz, 10% DAT, 4 ohmios)

15 W + 15 W (CA, 50 a 20.000 Hz, 10% DAT, 4 ohmios)

Sensibilidad de entrada/Impedancia

Teclado: 150 mV/50 k ohmios

Micrófono (mono): 0,5 mV/10 k ohmios

Relación señal-ruido: 75 dB

Potencia nominal por canal: 10 vatios (CA/CC, 10% distorsión armónica total, 4 ohmios)

Respuesta de frecuencia: 20—30.000 Hz, \pm 3 dB

SECCION DE PANTALLAS ACUSTICAS

Typo: De 2 vías, reflectoras de bajos

Altavoz de graves: Cónico de 12 cm

Altavoz de agudos: De cúpula de cerámica de 3 cm

Impedancia: 4 ohmios

GENERAL

Alimentación (CA)

EE. UU. y Canadá: 120 V/60 Hz

Europa: 220 V/50 Hz

Reino Unido y Australia: 240 V/50 Hz

Otras regiones: 110/120/220/240V, 50/60 Hz

Alimentación (CC): 15 V (10 pilas D ó R20)

Dimensiones totales (an x al x prof):

675x246x207 mm

Dimensiones del PC-8 (an x al x prof):

340x246x203 mm

Dimensiones de las pantallas (an x al x prof):

165x246x207 mm

Peso: 12 kg (sin pilas)

Las especificaciones están sujetas a cambios sin previo aviso.

SINCE 1887  **YAMAHA**
NIPPON GAKKI CO., LTD. HAMAMATSU, JAPAN